

Data Sheet



Article number: 604132056030

Description: Taper bored timing belt pulley
HTD 56 8M 30 TL 2012

Measures

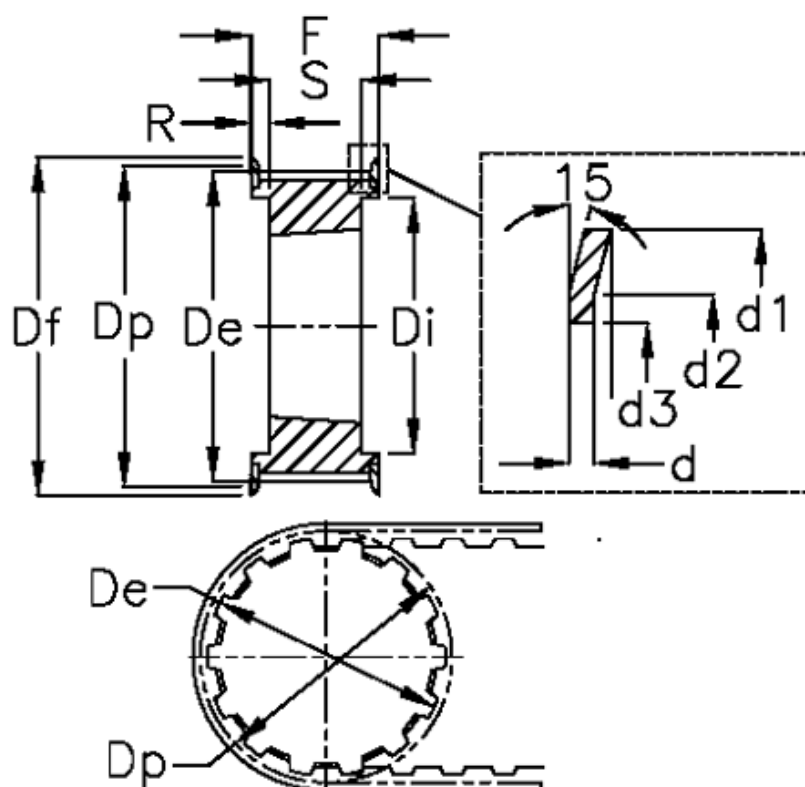

d = 1.5	F = 38	Weight = 3.76
d1 = 150	Flange type = F48	Width = 30
d2 = 145	For bushing = 2012	
d3 = 130	Max bore = 50	
De = 141.23	r = 6	
Df = 150	S = 32	
Di = 110	Tooth number = 56	
Dp = 142.6	Type = 8M	